

A8 **EIR**
對花壓紋

SEMI太格 鑽石卡扣地板

Technical Data 技術規範

Characteristics	Test Method	Result
Thickness 厚度	-	6.0 mm
Dimension 尺寸	-	228x1500 mm
Thickness of wear layer 耐磨層	-	0.5 mm
Wear Resistance 耐磨性	ASTM D4060-14(CS-17,250g)	≥60,000 轉
Resistance to Fire 防焰性	CNS 7614	防焰一級
Formaldehyde Emission 甲醛釋放量	CNS11342	ND 未檢出
Phthalates 八大塑化劑 DEHP/DBP/BBP/DINP/DIDP/DNOP/DMP/DEP	CNS15138-1(2012)	ND 未檢出
Chemical Products Resistance 耐藥品性	CNS8907	無變化
Water Absorption Scale Change Rate 吸水尺度變化率	CNS8907	變化率 0%
Main Ingredient 主要成分	FTIR&TGA	無機物碳酸鈣
Slip Resistance 防滑性	DIN 51130	R9
Heavy Metal 八大重金屬	ASTM F963-17	ND 未檢出



more...

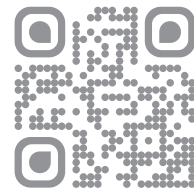

A8

EIR
對花壓紋

SEMI 太格 鑽石卡扣地板

8.0 mm

完成面(6+2)

V2.0

A8 **EIR**
對花壓紋
鑽石卡扣地板

8.0mm | Stain Resistance
完成面(6+2)



SEMI太格
鑽石卡扣地板

- STAIN RESISTANCE
- WATER PROOF
- WEAR RESISTANT

晶鋼漆
stain resistance

耐刮表面處理

地板結構

面材：6mm 大版木紋尺寸：228x1500mm 中間層：2mm
【可另選訂製品：大版石紋、人字拼】

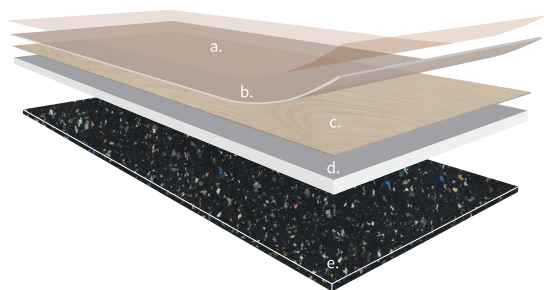

- a 超抗污晶鋼漆表面處理
- b 透明亞光耐磨層0.5mm
- c 3D木紋層
- d 硬質礦物基材
- e 中間層(標配/選配)

德國橡膠隔音墊、歐洲波浪隔音墊
皆取得內政部隔音認可通知書(含太格礦石)



中間層 underlay

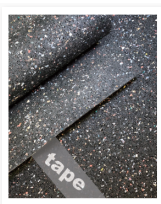

標配 2.0mm
德國橡膠隔音墊



選配 2.3mm
歐洲波浪隔音墊



選配 1.2mm
鋁箔EPE彈性墊



A8 **EIR**
對花壓紋
礦石卡扣地板



More photos

Stain Resistance / Water Proof / Wear Resistance

A8 **EIR** | 6305-1



晶鋼漆

stain resistance



A8  對花壓紋
礦石卡扣地板



More photos

Stain Resistance / Water Proof / Wear Resistance

A8  | 6305-1



A8  | 5803-27

size: 6.0 x 228 x 1500mm

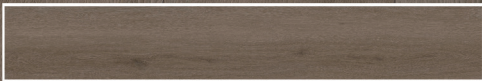



A8  | 5803-10

size: 6.0 x 228 x 1500mm





A8  | 6305-1

size: 6,0 x 228 x 1500mm





A8  | 5803-12

size: 6.0 x 228 x 1500mm





A8  | 5803-26

size: 6.0 x 228 x 1500mm





A8  | 6305-6

size: 6.0 x 228 x 1500mm



Product Characteristics

產品特性

- 防水、耐重壓、防焰一級
- 八大塑化劑、重金屬未檢出
- 大版規格尺寸，穩定性佳
- 超抗污晶鋼漆表面處理，耐刮性佳
- 隔音性佳、施工簡便（免上膠施工）

耐高溫測試

採用全球最新技術製造，主要穩定成分為天然石灰石礦物。



耐高溫測試影片

Video



傳統地板遇高溫環境穩定性較差。

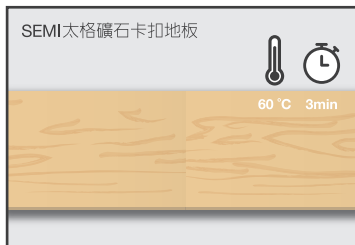

本產品遇高溫環境不翹起變形。



*Interior
installation notes*

安裝說明

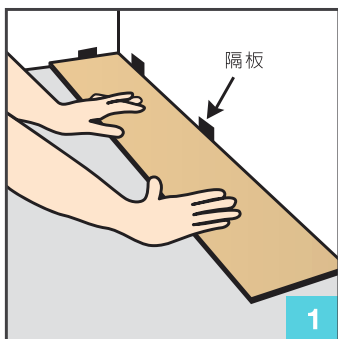

將第一片地板從角落開始放置，並將公槽朝向牆壁。使用隔板留出與牆壁之間 $\geq 5\text{mm}$ 的伸縮縫（視面積大小調整之）。

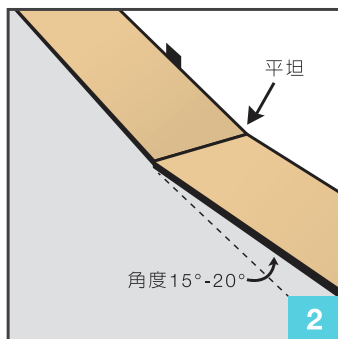

安裝第二片地板時，短向使用15-20度的角度扣入第一片地板，並注意靠牆的邊角處，地板需平坦不翹曲。

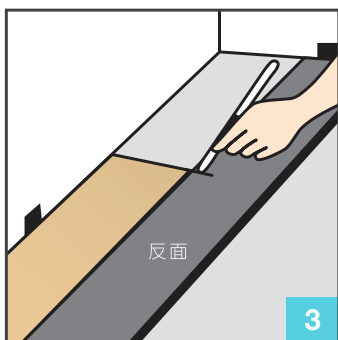

安裝每排最後一片地板前，將一完整地板反面放置在旁，標記所需長度後，用尺與工程美工刀割出痕跡並折斷，接著同樣以步驟2方式安裝。

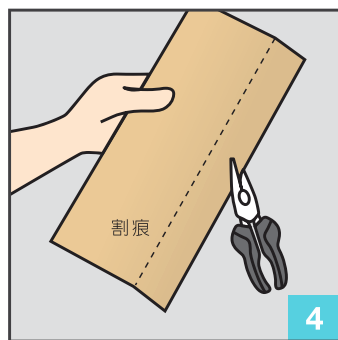

折斷地板可使用鉗子來輔助。

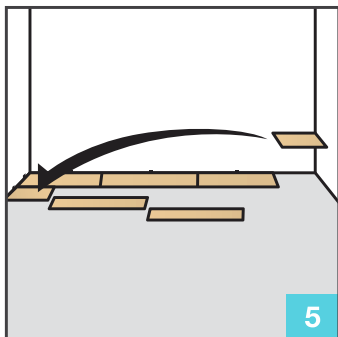

安裝第二排的第一片地板，可使用前步驟中切掉的剩餘部分，此步驟可錯開相同紋理，使地板紋理拼起來不致於太過死板。



安裝第二排地板時，建議將整排地板短向扣好後，再將長向地板以15-20度的角度傾斜扣入第一排地板。剩餘的每一排皆採取相同作法。

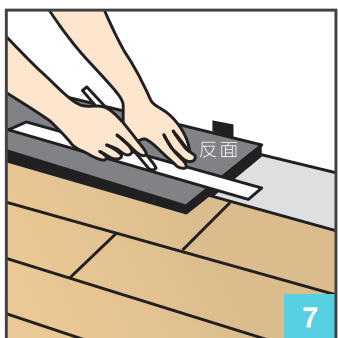

在鋪設最後一排地板時，將地板反面測量所需寬度後進行切割。注意公槽需朝向牆面，並且預留 $\geq 5\text{mm}$ 的伸縮縫（視面積大小調整之）。



門底部與地板之距離至少為1cm。在鋸門框底部時，將地板反面放置門框旁，以測量正確裁切高度，好讓地板能輕易地安裝於門框底下。